

UV Series Rotary Vane Vacuum Pumps



UV50

Since 1923 Pneumofore has designed and produced vacuum pumps featuring original solutions, the result of constant efforts in research and development.

The current UV rotary vane vacuum pumps are easy to install, operate fully automatically, and represent the simplest and most inexpensive system for vacuum plants. Our pumps achieve a high degree of vacuum through a wide pressure range of practically constant flow. This allows performances equal to larger size pumps, with considerable energy savings. The UV series vacuum pumps, complying with most international regulations, are valued in many industrial applications thanks to their low life cycle cost, safety, environmental compliance, low noise level, compactness, high performances, design simplicity, reliability and durability.

Main Features	Components
<ul style="list-style-type: none"> • Air cooling through an aluminum radiator and a temperature controlled fan. • Operation without cooling water avoids problems related to limestone, ambient temperature and unstable vacuum degree. • “Closed-loop” lubrication circuit ensures negligible coolant consumption. • Single-stage suction volumes from 177 cfm to 1908 cfm. • 99,95% maximum vacuum degree [0.015 InHg(A)] with performance curves constant up to 95%: the best achievable result by a single stage vacuum pump. • Special aluminum alloy vanes provide active sealing according to the traditional Pneumofore feature and guarantee a stable performance even after years of operation, avoiding efficiency loss and minimizing cost of operation and maintenance. • Reduced electric energy consumption when compared to liquid ring pumps with same nominal capacity. • “Plug and play” pumps, easy to install and integrate. • Variable speed option for operation 35 to 60 Hz and constant flow and/or vacuum level. 	<ul style="list-style-type: none"> • Intake air filter with polyester cartridge (3 or 5 µm). • Coolant filter cartridge for lubrication circuit. • Coolant separator and coolant recovery for air delivery. No coolant vapors. • Cylinder-integrated non return valve avoids air and coolant backflow. • Direct coupling between cylinder and electric motor. • Limited footprint - soundproof [75 dB(A)] - cabin, no foundations required. • Fully automatic operation: coolant temperature control, auxiliary control switches, safety vacuum gauge, system alarms and motorized suction valve. • Control panel with vacuum gauge, coolant separator cartridge pressure drop indicator, hour meter, active circuits control warning light, manual security button and key starter. • Very low maintenance cost thanks to design simplicity and to few moving parts subject to wear. • Vertical layout (for UV4, UV8 and UV16) for space economy. • Standard CE marking, US marking is optional.

Applications
<ul style="list-style-type: none"> • food processing • packaging • can manufacturing • material handling • plastic heat moulding • bricks production • degassing • polymers production • aluminum moulding • glass moulding • printing and paper

Technical data	60 Hz	UV4	UV8	UV16	UV30	UV50
Capacity	cfm	177	327	686	1254	1908
Maximum vacuum	%	99.95				
Minimum pressure	InHg(A)	0.015				
Pump motor	HP	9	18	35	75	125
Rotation speed	rpm	1740	1750	1750	1765	1770
Fan motor	HP	0.11	0.16	0.6	1.2	1.6
Intake connection	DN	2½" BSP	4" BSP	4"	6"	8"
Discharge connection		2" BSP	3" BSP			6"



Pneumofore engineers help customers to design the most suitable vacuum system for any application and assist them during regular operation as well as long-term maintenance.

UV16 vertical layout

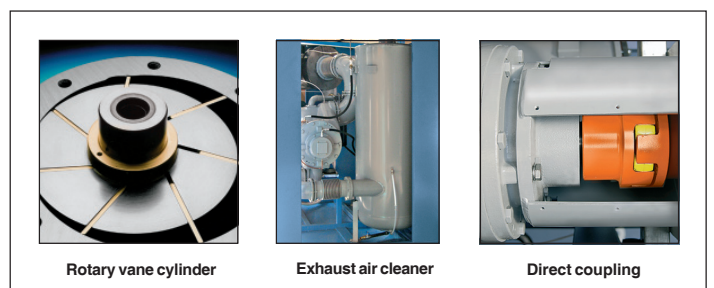

Rotary vane cylinder

Exhaust air cleaner

Direct coupling

Components and Schematic Operating Diagram

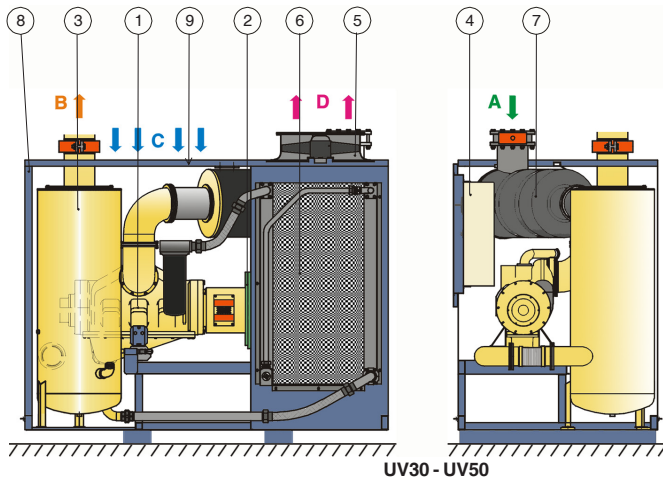

UV30 - UV50

- A Air intake
- B Outlet
- C Cooling air inlet
- D Cooling air outlet

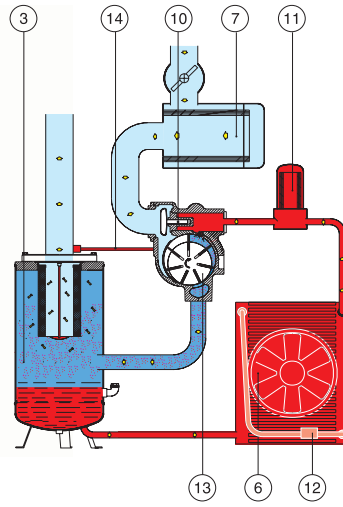

- 1 Cylinder block
 - 2 Electric motor
 - 3 Coolant receiver and coolant separator
 - 4 Control panel
 - 5 Fan
 - 6 Coolant radiator
 - 7 Air intake filter
 - 8 Soundproof cabin
 - 9 Cooling inlet air filter
 - 10 Non-return valve
 - 11 Coolant filter
 - 12 Thermostatic valve
 - 13 Rotor
 - 14 Coolant recovery
- Air / coolant
■ Coolant circuit
■ Air circuit

Dimensions

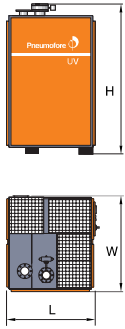

	UV4	UV8	UV16	UV30	UV50
length	32.5	63	54.5	89.3	105
width	36	26.8	50.4	57	59
height	46	70	85.8	80.7	88.6
weight	441	1720	2359	3968	4630

Standard Installation

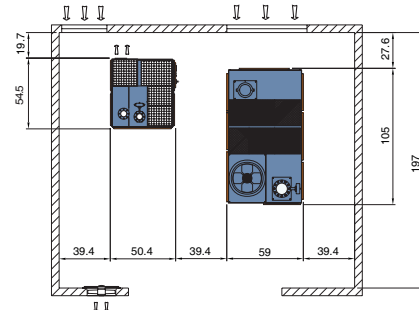
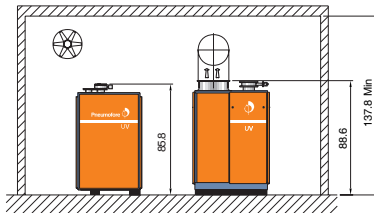
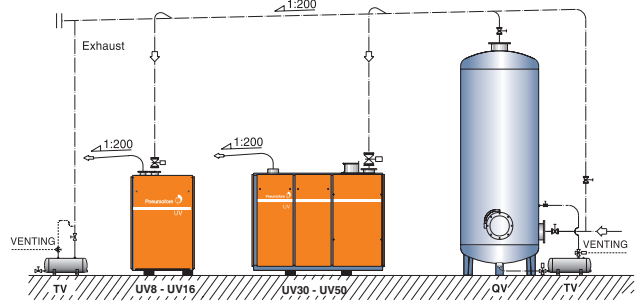

Vacuum Flow Diagram (60Hz)

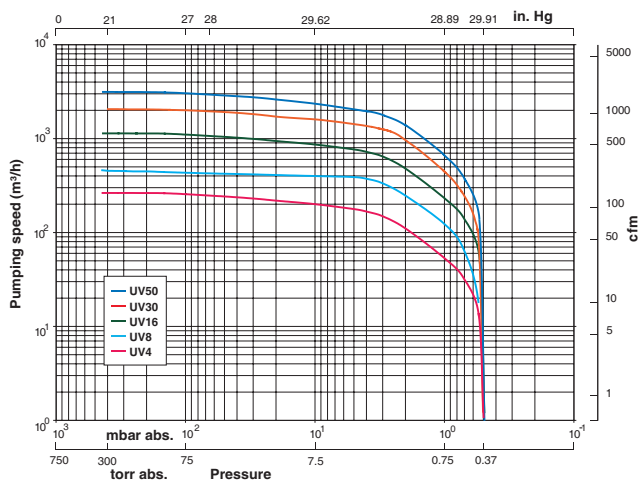

Pneumofore S.p.A.
Headquartes
Via N. Bruno, 34
10098 - Rivoli (TO) - Italy

Tel: +39 011.950.40.30
Fax: +39 011.950.40.40
Email: info@pneumofore.com
Web: www.pneumofore.com



UNI EN 9001: 2000
and ISO 14001: 2004

Pneumofore strives to constantly improve its products and reserves the right to modify technical data with no prior notification. Contents of this documents are for informational purposes only and do not constitute a guarantee extension of any kind. Trademark and logo Pneumofore® are registered worldwide. Copyright © Pneumofore SpA All rights reserved. Any unauthorized reproduction or dissemination of this document is strictly prohibited.

**Since 1923 • Air Compressors and Vacuum Pumps
Plant Engineering • Worldwide Service**